

DADI ESAGONALI

TIPO ALTO

ISO

4033

UNI

5587

DIN

-

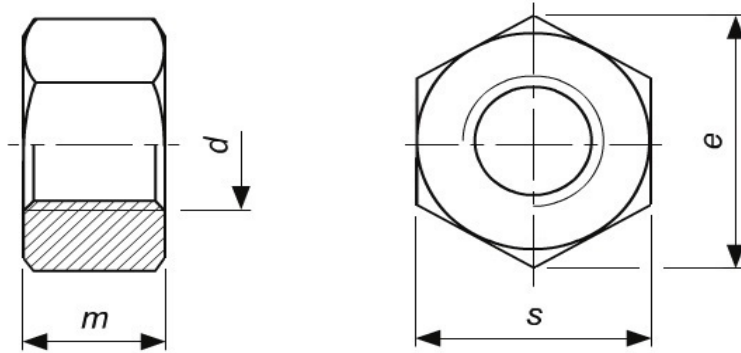

Materiale :

INOX

Classe :

A4

Filettatura :

passo GROSSO



Pesi per 1.000 Pz.

Per viti	passo	s	m	e	Peso
M 2	0,40	4,0	2	4,38	0,17
M 2,5	0,45	5,0	3	5,45	0,37
M 3	0,50	5,5	3	6,01	0,47
M 4	0,70	7,0	4	7,66	1,00
M 5	0,80	8,0	5	8,79	1,52
M 6	1,00	10,0	6	11,05	2,96
M 7	1,00	11,0	7	12,12	3,93
M 8	1,25	13,0	8	14,38	6,50
M 10	1,50	17,0	10	18,90	14,30
M 12	1,78	19,0	12	21,10	20,30
M 14	2,00	22,0	14	24,49	31,50
M 16	2,00	24,0	16	26,75	40,50
M 18	2,50	27,0	18	29,56	58,20
M 20	2,50	30,0	20	32,95	79,10
M 22	2,50	32,0	22	35,03	94,90
M 24	3,00	36,0	24	39,55	137,00
M 27	3,00	41,0	27	45,20	200,00
M 30	3,50	46,0	30	50,85	284,00
M 33	3,50	50,0	33	55,37	361,00
M 36	4,00	55,0	36	60,79	483,00
M 39	4,00	60,0	39	66,44	623,00
M 42	4,50	65,0	42	72,09	795,00
M 45	4,50	70,0	45	76,95	988,00